

LEHNER



POLARO®

Operating instructions with parts list

Status: January 2011

Serial number:

Original operating instructions

LEHNER Agrar GmbH

Häuslesäcker 5-9
D-89198 Westerstetten

Tel.: (+49) 07348 95 96 0

Fax: (+49) 07348 95 96 40

www.lehner.eu

info@lehner.eu

It is prohibited to distribute or duplicate this document and to utilise or disseminate its content without express permission. Non-compliance shall result in claims for damages. All rights for patents, utility patents and industrial patents are reserved by Lehner.

English

Table of Contents

Content

1	What you should know	6
1.1	Foreword	6
1.2	About these operating instructions	6
1.3	Description of the POLARO®	7
1.4	Intended use	9
1.5	Reasonably foreseeable misuse	9
1.6	Warranty	9
1.7	For your safety	10
2	Mounting and operation	11
2.1	Mounting the frame	11
2.2	Mounting the hopper	12
2.3	Electrical connection	13
2.4	Filling the spreading material hopper	14
3	Operating the POLARO®	15
3.1	Controls on the control panel	15
3.2	Switching the spreading disc and agitator on and off	16
3.3	Setting the speed	18
3.4	Setting the slide opening	18
3.5	Opening/closing the slide	19
3.6	Setting the spreading width	20

Table of Contents

4	Settings	21
4.1	Turning	21
4.2	Determining the spreading width.....	22
5	Maintenance and cleaning	23
5.1	Maintenance.....	23
5.2	Cleaning	26
5.3	Transport and storage	26
6	Appendix	27
6.1	EC Declaration of Conformity.....	27
6.2	Identification	28
6.3	Distribution box terminal assignment	29
6.4	Troubleshooting.....	30
6.5	List of spare parts.....	31
6.5	List of spare parts.....	32

1 What you should know

1.1 Foreword

With the **POLARO®**, you have purchased a high-quality and innovative product. Thank you for choosing a Lehner product. Thanks to its advanced design, meticulous material selection, state-of-the-art manufacturing techniques and the precision work of our employees, this machine meets all efficiency, quality, reliability and value requirements.

Maintenance and care in accordance with the operating instructions ensure the safety of the machine and retain the value of your **POLARO®**.

1.2 About these operating instructions



These operating instructions are part of the **POLARO®** and must always be kept to hand. All persons who work with the **POLARO®** must read, understand and observe the operating instructions.

The operating instructions should be retained for subsequent use. If at a later date you decide to sell your **POLARO®**, you must also hand over these operating instructions; they are an integral part of your machine.

1 What you should know

Warning notices

Warning notices in these operating instructions are identified as follows:

	Danger! Warning against immediate danger. Non-compliance with measures can result in death, severe personal injury or serious damage to property.
	Warning! Warning against possible danger. Death, severe personal injury or serious damage to property are possible.
	Caution! Warning against possible dangerous situations. Minor personal injury or damage to property is possible.

1.3 Description of the POLARO®

The POLARO® is a spreader for spreading de-icing salt, grit, sand and granulated fertiliser. It consists of a solid frame, a spreading material hopper and the electrical components. The spreading disc with slide/dosing device is part of the frame. The electrical components include the drive motor, speed sensor, distribution switch box, control panel cable, control cable, battery cable, control panel and automatic spreader-bar release.

A separate motor drives a slow-running agitator for grit, sand, free-flowing salt or granulated fertiliser. For salt that is moist or not free-flowing, there is a special agitator for refined salt which is available as an alternative accessory. The agitator is fitted vertically in the hopper.

A control panel regulates the speed of the spreading disc and the slide from the driver's cab.

The POLARO® can be attached to the front or the rear of approved carrier vehicles.

1 What you should know

Technical data

	POLARO® 70	POLARO® 110	POLARO® 170
Dimensions L/W/H	570/485/870 mm	570/485/1050 mm	700/626/1070 mm
Unladen weight	29 kg	38 kg	42 kg
Volume	70 l	110 l	170 l
Salt capacity	90 kg	130 kg	220 kg
Operating voltage	12 to 15 V		
Fuse	25 A		
Power of drive motor (spreading disc)	60 W		
Power of agitator motor	150 W		
Speed range	40 to 600 rpm		
Speed of standard agitator	54 rpm		
Speed of refined salt agitator	27 - 29 rpm		
Power consumption of motor	Start up to 25 A Normal operation up to 13 A		
Operating temperature	-10 °C to +70 °C		
Storage temperature	-30 °C to +70 °C		
Length of battery cable	3 m	5 m	5 m
Length of control panel cable	2 m	2 m	2 m
Length of control cable	3 m	6 m	6 m

1 What you should know

1.4 Intended use

The **POLARO**[®] is a spreader for spreading de-icing salt, grit, sand and granulated fertiliser.

1.5 Reasonably foreseeable misuse

Only use on approved carrier vehicles with suitable vehicle electrics and sufficient stability.

Only use for the approved media. The machine must not be used to spread pesticides.

1.6 Warranty

We provide a guarantee of 6 months and warranty of 12 months on the **POLARO**[®].

Warranty repairs must be coordinated with the manufacturer before any work is started.

For replacement parts, additional expenses are automatically charged for any changes made to cables and plugs by the customer. Replacement parts are to be returned carriage paid.

Any change to cable or plug connections without factory approval automatically invalidates the entire warranty. Rusted bearings are not subject to the manufacturer's warranty. Motors may not be opened or dismantled.

Upon receipt:

Check your **POLARO**[®] for any damage caused in transit. Any such damage must be reported to the manufacturer within 24 hours of receipt.



1 What you should know

1.7 For your safety

- Carefully read these operating instructions before use and observe them. Always keep these instructions to hand at the point of use.
- Adhere to the accident prevention regulations, safety and operating regulations and the regulations for environmental protection.
- Adhere to all applicable standards and guidelines.
- Follow the safety instructions.
- Before operation, check that the hopper is correctly positioned in the hopper platform and that the spreader is securely and properly fastened to the carrier vehicle.
- Do not operate the spreader if there are any safety-related defects.
- Immediately resolve any safety-related defects.
- When travelling on public roads and streets, follow the road traffic regulations.
- No persons must be in the spreading zone.
- Switch off the motor to remedy faults.
- Disconnect from the power supply for repair work.
- Never open the hopper when the agitator is running.
- Do not touch the hopper during operation.
- Never touch running or blocked spreading discs when the drive motor is running.
- Observe the relevant spreading material manufacturer's instructions.
- Contact the relevant spreading material manufacturer for spreading tables and other information about the spreading material used.
- LEHNER Agrar GmbH accepts no liability for the storage and application of spreading material.

2 Mounting and operation

2.1 Mounting the frame

	<p>Warning! Risk of injury due to high component weight</p> <p>The spreader is much heavier when the hopper is full. For this reason, ensure that the spreader is mounted correctly on the carrier vehicle and check the carrying capacity of the platform gates or other consoles. Mount with support if necessary.</p>
	<p>Warning! Risk of injury</p> <p>The load capacity should be in line with the specifications for load lifting appliances.</p>
	<p>Warning! Risk of injury</p> <p>Do not operate the spreader if there are any safety-related defects.</p>

The **POLARO**[®] can be attached on the front or rear of the tractor, off-road vehicle or ATV.

The **POLARO**[®] can be mounted using an auxiliary bracket. Mounting holes are provided for this purpose on the back of the frame.

Remove the hopper during the mounting process.

The recommended delivery height is 0.40 - 1.00 m.

For information about disassembly, see chapter 5.1 - Maintenance.

2 Mounting and operation

2.2 Mounting the hopper



Warning!



Risk of injury and damage to the spreader

For salt that is not free-flowing, there is a special agitator for refined salt which is available as an alternative accessory. This agitator is not suitable for grit and sand.

1. Mount the hopper.
2. Check whether the hopper fits well in the hopper platform. (See arrow)
3. Check that the **POLARO**[®] is securely attached.

2 Mounting and operation

2.3 Electrical connection

	<p>Caution! Risk of malfunctions Defective plugs and cables or those of the wrong size can lead to malfunctions. Use original or cables and plugs approved by the manufacturer only.</p>
	<p>Caution! Risk of short-circuit Ensure that the cable is not routed over any sharp edges.</p>

Any change to cable or plug connections without factory approval automatically invalidates the entire warranty. Changes to cables undertaken by the customer will be charged in the case of repair.

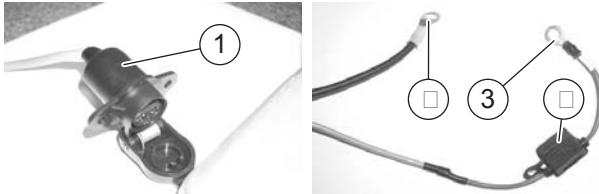

1. Mount support for the control panel in the vehicle cab.
2. Plug the control panel cable into the 3-pin plug **1** of the carrier vehicle.
If the plug **1** is not available, use the battery cable supplied:
 - Connect terminal **2** to the negative pole of the battery (not to the body).
 - Connect terminal **3** (with fuse **4**) to the positive pole of the battery
 - Insert cable end with plug **1** into the carrier vehicle.

2 Mounting and operation

3. Plug the spreader cable into the 16-pin plug of the control panel.

The battery cable supplied must be used to ensure an optimum power supply.

	<p>Caution! Risk of short-circuit Observe the adapter manufacturer's mounting instructions.</p>
---	---

When mounting a 12/24 V adapter (available as an accessory), a separate on/off switch must be connected in the 24 V supply line, because the adapter needs power in standby mode.

The machine is now ready to operate.

2.4 Filling the spreading material hopper

	<p>Caution! Health risk Observe the spreading material manufacturer's specifications.</p>
---	---

	<p>Warning! Risk of injury Never open the hopper or touch the spreading disc when the drive motor is running.</p>
--	---

1. Add the spreading material immediately before starting work.
2. Lock the hopper after filling.

3 Operating the POLARO®

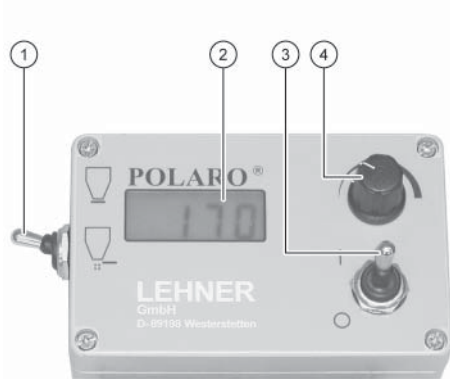

3.1 Controls on the control panel



- 1 Rocker switch - opening the slide (rocker switch at bottom) and closing the slide (rocker switch at top)
- 2 Display
- 3 Rocker switch - switching on and off
- 4 Speed controller for spreading disc

3 Operating the POLARO®

3.2 Switching the spreading disc and agitator on and off

	<p>Danger! Risk of injury due to accident</p> <p>When travelling on public roads and streets, follow the road traffic regulations.</p>
	<p>Warning! Risk of injury</p> <p>When the spreader is switched on, the drive motor starts up immediately. Ensure that no-one is in the danger zone when the spreader is switched on.</p>
	<p>Warning! Risk of injury</p> <p>Do not operate the spreader if there are any safety-related defects.</p>

- |  Activate the rocker switch on the front of the control panel.
- The speed of the spreading disc is indicated on the display.

170

Before switching off the spreader, the slide should be closed.

If this message is shown in the display, a sensor or a cable is damaged, a plug disconnected or magnets on the spreading disc are missing.

ERR

3 Operating the POLARO®

Autostart/automatic freewheeling

If an agitator motor is difficult to start due to heavy loads, the motor starts up to 10 times in alternating motor direction. The slide must be open for this so the material flows off.

If the agitator or spreading disc cannot break free, the motor is automatically switched off. The following message appears in the display:

ERR



Warning!

Risk of injury due to agitator or spreading disc starting up unexpectedly

Switch off the motor to remedy the fault.

To eliminate the blockage:

1. Switch off the machine.
2. Manually turn the spreading disc or empty the hopper.

For more information, see chapter 6.4 - Troubleshooting.

3 Operating the POLARO®

3.3 Setting the speed



The speed of the setting disc can be set on a continuous scale using the rotary knob on the control panel.

170

The value indicated on the display is the desired value which the machine will attempt to maintain. If this value cannot be achieved due to the motor having too high a load or the power supply being weak, the value actually achieved is displayed once the motor has been powered up.

The displayed values are not speed indicators, but set values.

3.4 Setting the slide opening

1. Ensure that the slide is closed.
2. Set the slide controller on the spreader to the desired application rate.

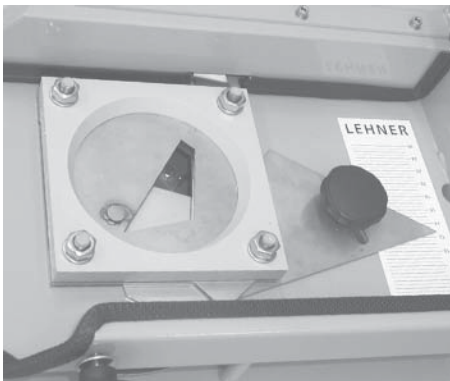

In position 0, the slide is closed, and in position 20, it is opened as far as possible. In the area in between, the slide opening can be set on a continuous scale.

3 Operating the POLARO®

3.5 Opening/closing the slide

Before opening the slide, ensure that the **POLARO®** is switched off, otherwise spreading material is spread immediately.



Activate the rocker switch on the left of the control panel to open or close the slide.

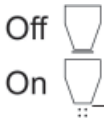

The switch position indicates whether the slide is open or closed.

Before switching off the spreader, the slide should be closed.

Re-adjusting the slide

The slide elements are spaced so that no spreading material gets stuck. To prevent the slide from sliding into the discharge opening during vibrations and thereby causing wear, a pulse adjusts the slide according to the "on" or "off" position roughly every 60 seconds. However, this only happens when the main switch is switched on.

For information about troubleshooting, see chapter 6.4 - Troubleshooting.

3 Operating the POLARO®

3.6 Setting the spreading width

The spreading width depends on the condition of the spreading material and the speed of the spreading disc. The more coarse the spreading material, the larger the possible spreading width.

4 Settings

4.1 Turning

1. Put the spreader in the carton or put the carton over the spreader to catch the spreading material.
2. Due to the pull, the the spreading disc speed used in practice must be set.
3. Weigh out the ejected spreading material at various slide positions until the suitable slide position is determined.

4 Settings

4.2 Determining the spreading width

Please refer to the relevant spreading material manufacturer's information for reference values for the spreading width.

1. Spread on a firm surface.
2. Weigh spreading material or sweep into a pile across the direction of travel and assess the side distribution.

Formulas

$$\frac{\text{Gram/min}}{\text{Speed in m/min} \times \text{Spreading width in m}} = \text{Output in gram/m}^2$$



$$\frac{\text{Gram/min}}{\text{Output in gram/m}^2 \times \text{Spreading width in m}} = \text{Speed in m/min}$$

$$\text{Desired output in gram/m}^2 \times \text{Speed in m/min} \times \text{Spreading width in m} = \text{Gram/min}$$

In position 0, the slide is closed, and in position 20, it is opened as far as possible. Now the right value can be found by turning again at a different scale setting. The output and side distribution must however be checked when starting work.

5 Maintenance and cleaning

5.1 Maintenance

	<p>Warning! Risk of injury Disconnect from the power supply for repair work.</p>
	<p>Warning! Risk of injury due to high component weight Disassemble with support if necessary.</p>
	<p>Warning! Risk of injury Always wear goggles, a breathing mask and gloves when cleaning with compressed air. Observe the spreading material manufacturer's specifications.</p>

After using the spreader, empty the hopper and clean the spreader and carrier vehicle with a broom or compressed air.

Dosing device/slide

The dosing device and slide should be inspected and cleaned at regular intervals depending on use and the spreading material used. If using very fine spreading material in particular, the slide unit may clog.

5 Maintenance and cleaning

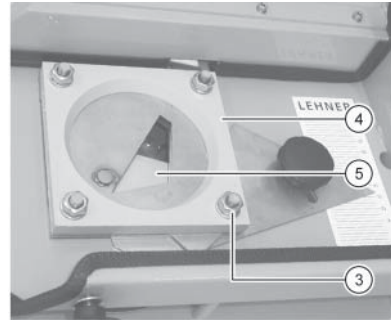
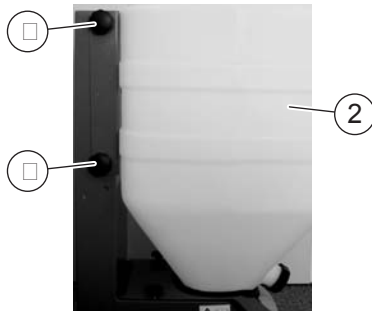

1. Remove agitator plug.
2. Unscrew knurled screws 1 at the top and bottom of both sides.
3. Remove the hopper 2.
4. Unscrew four nuts 3 with a 17 mm wrench.
5. Disassemble the hopper platform 4 and pull the dosage slide 5 out from the top.
6. Clean the slide unit with a broom or compressed air.
7. Fit parts in reverse order.
Standard lubricant can be applied to the bottom edge to assist with hopper installation.

5 Maintenance and cleaning

Drive motor

The spreading disc's drive motor should be cleaned and lubricated at the end of the season. This extends the service life of the motor. Carry out this maintenance work correctly otherwise the manufacturer's warranty may be invalidated.

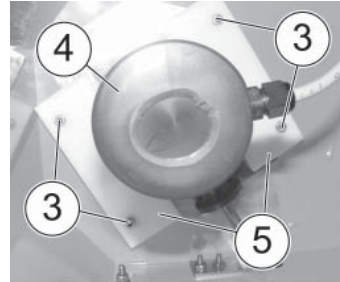
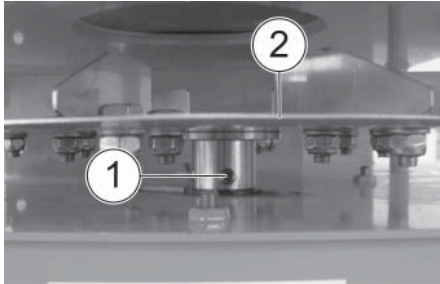

1. Remove agitator plug.
2. Loosen screw 1 on spreading disc 2 and pull spreading disc 2 up and off.
3. Remove plastic washer (thick).
4. Remove screws 3 from below and remove drive motor 4 with spacer and two guide rails 5.
5. Take plastic washer (thin) off motor shaft.
6. Clean motor shaft and contact surface of plastic washer and apply thin coat of standard copper paste.
7. Fit parts in reverse order.

5 Maintenance and cleaning

5.2 Cleaning

	<p>Warning! Risk of injury Disconnect from the power supply for cleaning work.</p>
---	--

	<p>Caution! Risk of injury Always wear goggles, a breathing mask and gloves when cleaning. Observe the spreading material manufacturer's specifications.</p>
---	--

The hopper can be almost fully emptied by means of the residual discharge.

1. Unscrew hopper.
2. Clean spreader and hopper with a broom or compressed air.



5.3 Transport and storage

Only use the truck available as a special accessory for transport.

	<p>Warning! Risk of injury due to the parked spreader toppling over Park the spreader on a clean, dry and stable surface. If it is going to be stationary for a longer period of time, the spreader may only be parked when it is completely empty.</p>
---	---

6 Appendix

6.1 EC Declaration of Conformity

	<p>In accordance with EC Directive 2006/42/EC</p> <p>Manufacturer:</p> <p>LEHNER Agrar GmbH</p> <p>Häuslesäcker 5-9 D-89198 Westerstetten Tel.: (+49) 07348 95 96 0 Fax: (+49) 07348 95 96 40 www.lehner.eu info@lehner.eu</p> <p>Person employed by the company with the authorisation to compile relevant technical documents:</p> <p>Helmut Lehner</p> <p>Lehner Agrar GmbH Häuslesäcker 5 - 9 D-89198 Westerstetten</p> <p>We hereby declare under our sole responsibility that the</p> <p>POLARO® spreader 70/110/170</p> <p>for spreading salt, grit, sand and granulated fertiliser, to which this declaration relates, complies with all the relevant conditions of EC Directive 2006/42/EC and the EMC Directive 2004/108/EC.</p> <p>Westerstetten, 05.01.2011 Helmut Lehner  Managing Director</p>
---	--

6 Appendix

6.2 Identification

The serial number of the spreader is located on the back of the frame. Note the serial number in these operating instructions so that it is readily available for inquiries.

6 Appendix

6.3 Distribution box terminal assignment

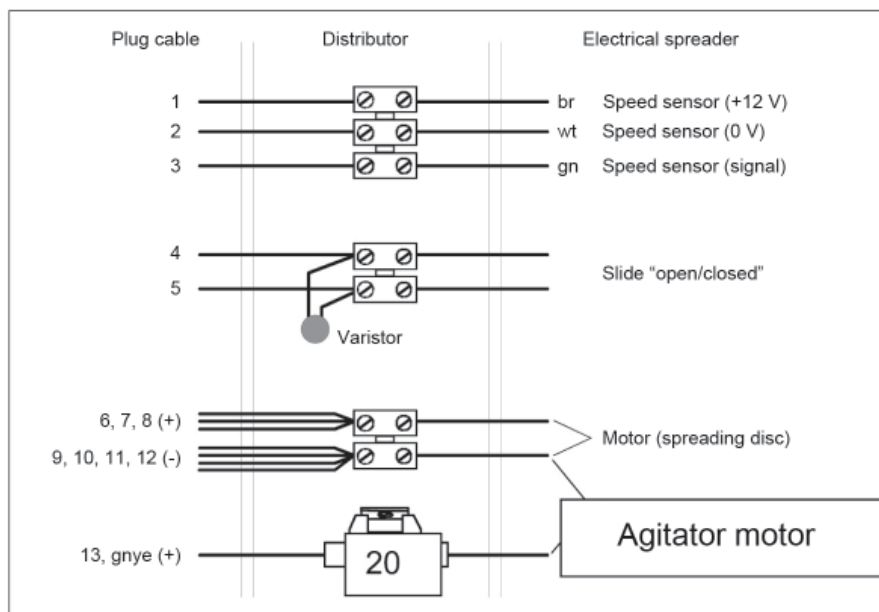
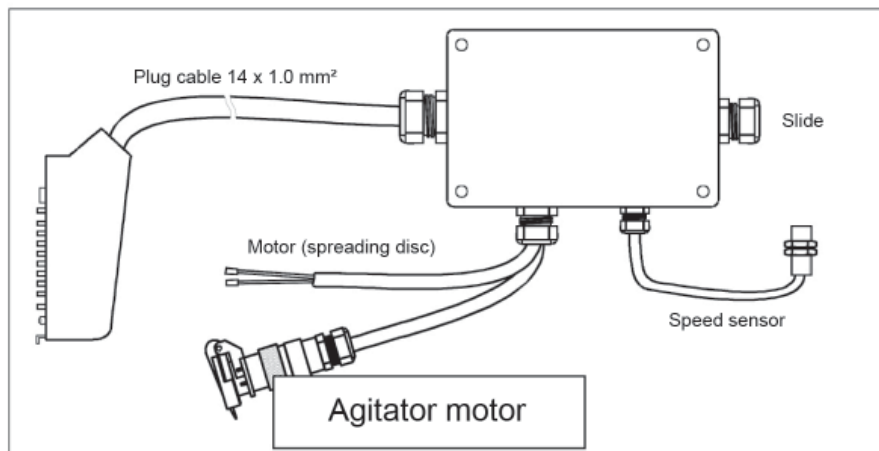

6 Appendix

6.4 Troubleshooting

Troubleshooting LEHNER POLARO®	
Status: 01/2011	
The following information should help you resolve minor problems yourself. If you have any questions, please do not hesitate to contact us. We will be happy to help.	
Problem	Cause
Solution	
The operating panel crackles	Loose contact on the power supply
No display	+ and - were switched, fuse is defective Warning: Unplug operating panel and rectify errors (Reverse voltage protection)
Spreading disc does not reach set speed	Excess load, motor bearing not running smoothly
Slide jams	Spreading material or dirt has got jammed in the slide
On the display: ERR	Spreading disc does not turn; switched off after 10 attempts Agitator does not turn; switched off after 10 attempts Material may be compacted too much. Control panel plug not connected to spreader or line damage Sensor damaged Magnets on spreading disc missing (8 must be available as standard) Poor plug connection for operating panel Drive motor doesn't reach speed or doesn't start up Original cable changed by intermediate plug/socket Agitator motor is consuming too much power
	Check contacts and fuses
	Check connections and fuses
	Check motor for ease of movement
	Check slide for foreign bodies and clean; see chapter 3.5 Opening/closing the slide
	Check spreading disc
	Start spreader again if necessary
	Check agitator; start spreader again if necessary
	Check plug connections and lines; Restart machine
	Replace sensor
	Attach magnets. It is however advisable to order a replacement spreading disc
	Clean the contacts on the 20-pin plug
	Check for motor damage; supply directly with 12 V.
	Check ruffling
	Empty hopper

6 Appendix

6.5 List of spare parts

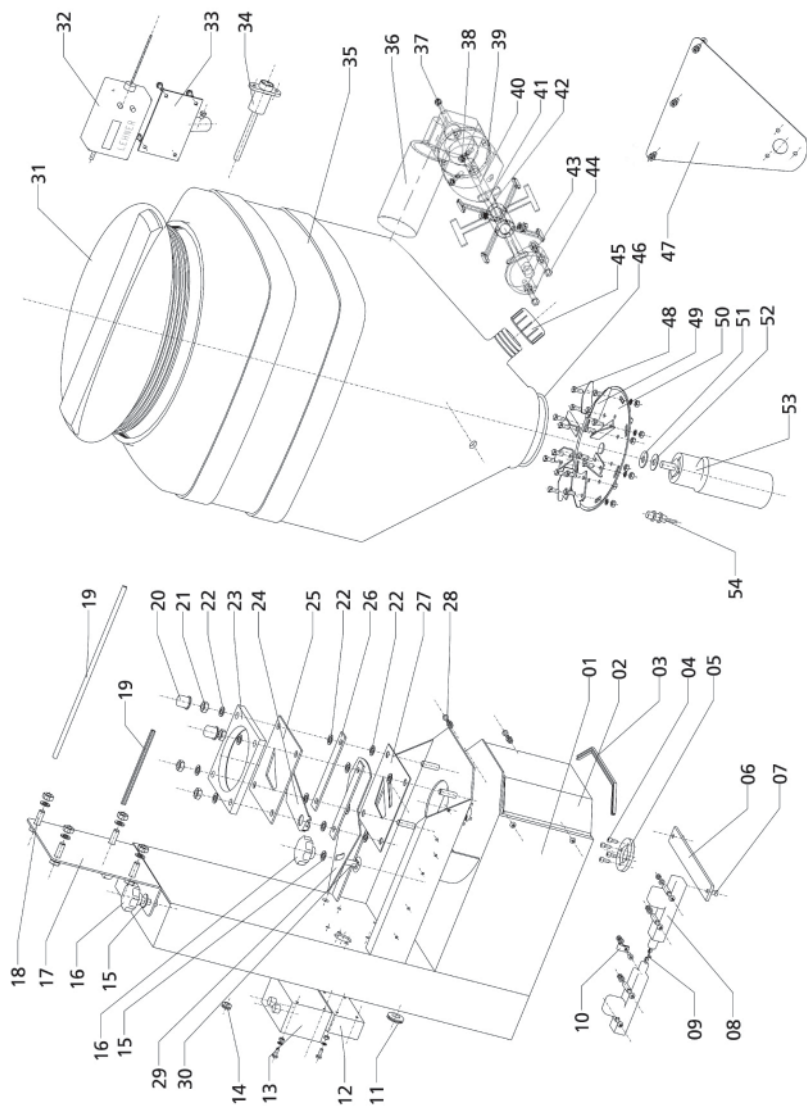

6 Appendix

6.5 List of spare parts

Spare part no.	Quantity	Designation	Size
1	1	Steel frame	
2	1	Front cladding	
3	1	Edge guard	
4	4	Allen screw	M 6 x 15
5	1	Compensating ring	
6	1	Counter bearing for motor	
7	2	Countersunk screw	M 6 x 15
8	2	Slide motor	
9	1	Connection hook	
10	3	Plastic cable clamp	
11	2	Cable protection sleeve	Diameter 20 mm
12	1	Distribution box	M 6 x 16
13	1	Automatic spreader-bar release with screw set	
14	1	Cable protection sleeve	Diameter 10 mm
15	2	Washer	Diameter 8 mm
16	3	Knurled nut	M 6
17	1	Hopper bracket	
18	4	Hexagon screw with washer and nut	M 10 x 25 mm
19	2	Edge guard	
20	2	Cover cap	
21	6	Hex nut	M 10
22	12	Washer	Diameter 10 mm
23	1	Hopper platform	
24	1	Slide	
25	1	Dosage slide, thick	
26	1	Counter bearing for slide	
27	1	Dosage slide, thin	
28	4	Fillister head screw with washer and nut	M 4 x 15
29	1	Dosing slide	
30	1	Carriage bolt	M 8 x 20
31	1	Hopper cover	
32	1	Operating panel	
33	1	Bracket for operating panel	
34	1	Battery cable with 3-pin plug and bracket	
35	1	Hopper	
36	1	Agitator motor	
37	4	Allen screw	M 6 x 30
38	3	Allen screw	M 6 x 8
39	1	Agitator bearing, motor side	
40	1	Agitator	
41	1	Agitator	
42	1	Safety screw for agitator	M 8 x 30
43	1	Counter bearing for agitator	
44	2	Allen screw	M 6 x 30
45	1	Discharge cover	
46	1	Seal	
47	1	Reinforcement plate	
48	1	Hexagon screw	M 6 x 15
49	8	Casting shovel	
50	1	Spreading disc with 2 Allen screws	M 6 x 8
51	1	Sealing disc on plastic frame	
52	1	Sealing disc in plastic motor	
53	1	Drive motor	
54	1	Speed sensor	